

# Zip HydroTap® G4

Filtered Chilled drinking water for residential kitchens and tea rooms.

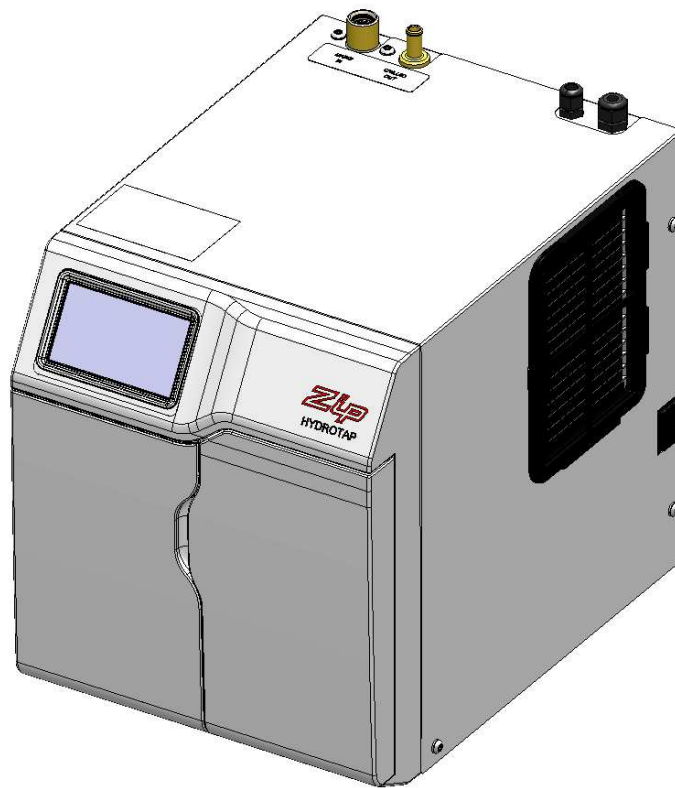

**Affix Model Number Label  
Here  
802261**



## Tap options

The HydroTap appliance series offers a range of interchangeable taps to suit the customer's needs (See options below). For ease of installation, it is recommended to fit the tap before installing the undersink unit. The installation procedure for each of the taps is detailed in a separate tap installation instruction book No. 803341, supplied with the tap.

For all operational features of the HydroTap, please refer to the Chilled User manual No.802262.

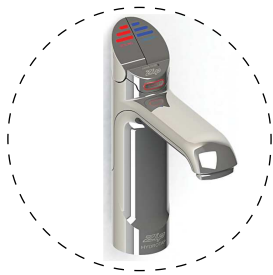

Classic Tap



Arc / Cube Tap



Elite Tap



Celsius Arc / Cube Tap

## HydroTap Specifications

Installation check list .....	4
General Product Features.....	5
Important Safety Instructions .....	6
Warnings and Regulatory Information.....	6
Major components and Accessories .....	7
Technical Specification .....	8
Before installation and site requirements.....	8

## Installation Instructions

### STEP 1 - Measure and cut all the tap holes before fitting the taps

Section 1 - Tap Installation instructions	
1 - HydroTap Tap installation .....	8

### STEP 2 - Check for adequate ventilation

Section 2 - Ventilation	
2.1- Details .....	9-10

### STEP 3 - Install the undersink unit

Section 3 - Undersink Unit Installation	
3.1- Fit the mains water supply hose .....	11
3.2- Model C .....	11
3.3- Model CHA.....	12

### STEP 4 - Commission the HydroTap

Section 4 - Commissioning	
4.1- language .....	13
4.2- Filter flush .....	13

## Trouble Shooting

Trouble Shooting Table.....	14
End of life disposal .....	15
Contact details .....	16

## Installation checklist

### Before Installation:

- A. Read the instructions and check if there is adequate space to mount all of the components.
- B. Note: Not all fittings are supplied with the appliance kit. Isolation valves are not supplied.
- C. Check the mains water pressure is between 172 - 700kPa
- D. Check the water quality to determine if extra filtration will be required.
- E. Check the appliance rating plate and ensure correct power is available for the appliance.
- F. Check the under counter cupboard supporting the appliance is adequate for the total weight of the appliance, when full of water.

### Before Commissioning:

- 1. Check the unit has been installed correctly.
- 2. Check all plumbing fittings have been tightened.
- 3. Ensure the outlet pipe is positioned to drain correctly.
- 4. Ensure there is adequate ventilation.
- 5. Check all tubes from the undersink unit to the tap, have a constant rise and there are no sags or kinks in the hoses.
- 6. Check all electrical connections are correct and there are no loose wires.

### Commission: (See section 4)

- 7. Flush the supply line before connecting.
- 8. Connect and turn on the water to check for leaks.
- 9. Flush the filter.
- 10. Where applicable, programme the unit to suit the customer's requirements.

## General Product Features

Thank you for purchasing a Zip Chilled HydroTap. Please read and follow these instructions carefully to ensure safe operation and trouble free service. If service is required, please call 1800 460 222

### What is the Zip HydroTap ?

The Chilled Zip HydroTap is electronically controlled to supply filtered and Chilled drinking water for kitchens and tea rooms. The Chilled HydroTap units are under bench drinking water appliances with a dispensing tap mounted on a sink or bench, which may be used for residential or commercial applications. This unit utilises a conventional refrigerant compressor to chill the water which is factory set to 6-10°C. These units are NOT designed to be used for sanitary fixtures.

The water filter is a disposable item which will require periodic replacement and is covered by a limited OEM warranty.

It is important that the Installation be done safely, correctly and completely, in order to utilise all the benefits the HydroTap can provide. Each unit can be ordered with the Tap Head Assembly for Disabled use. The disabled levers are supplied with Braille caps for the visually impaired.

### Usage:

The Zip HydroTap is intended for use in residential household and similar applications such as, rural and urban residential Kitchens, Hotels, Motels, Bed and Breakfast and other residential type environments.

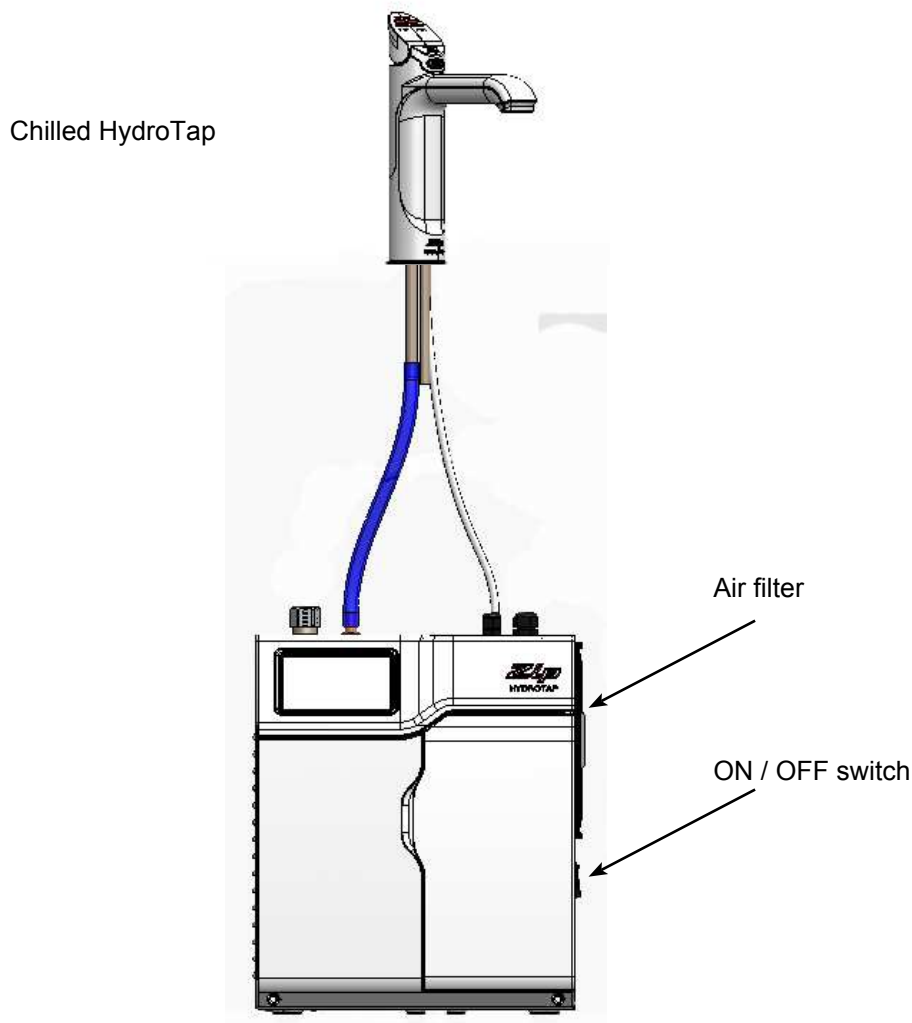

## Important Safety Instructions

This manual contains important safety, installation instructions for the Zip HydroTap G4. This appliance is not intended for use by persons (including children) with reduced physical, sensory or mental capabilities, or lack of experience and knowledge, unless they have been given supervision or instruction concerning use of the appliance by a person responsible for their safety. Children should be supervised to ensure that they do not play with the appliance. For products sold in Europe, this appliance can be used by children aged from 8 years and above and persons with reduced physical, sensory or mental capabilities or lack of experience and knowledge if they have been given supervision or instruction concerning use of the appliance in a safe way and understand the hazards involved. Children shall not play with the appliance. Cleaning and user maintenance shall not be made by children without supervision.



### Qualifications

If the power cable is damaged it must be repaired only by a qualified technician. To avoid hazards, all installation procedures must be carried out by a suitably qualified tradesperson. The power cable and power outlet must be in a safe visible position for connection.

### Lifting

Take care when lifting the Zip HydroTap unit. Some units may exceed safe lifting limits. If you feel this is beyond your personal capabilities, please seek assistance with the lift. The weights of the units are marked on the packaging. Do not lift the unit by the front cover or any connections at the top rear of the unit. Refer to page 7 for the weight of your product.

### Airflow

The ambient temperatures this unit should operate within are 5°C - 35°C. Proper air circulation must be provided. The system will operate satisfactorily only if the recommended air gaps are provided. If a vent kit is supplied it must be fitted. See technical specifications for correct installation to prevent overheating.

### Positioning





It is important to ensure the undersink unit is positioned in an accessible area close to the floor level. The unit must have its base mounted in a horizontal position with all inlets and outlets facing up. The Tap must be located above the undersink unit. See section 1.



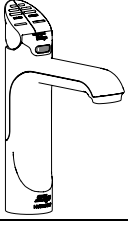
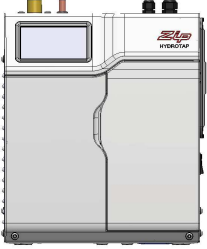

### WARNINGS

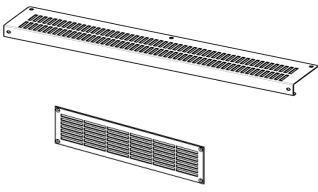
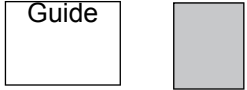
1. The Zip HydroTap unit must be earthed. The resistance of the earth connection from each exposed metal part must be less than 1 ohm.
2. All Installation and service work must be completed by trained and suitably qualified Tradespeople. Faulty operation due to unqualified persons working on this product, or any other Zip product may void warranty coverage.
3. All Plumbing must comply with AS/NZS3500.
4. All Electrical must comply with AS/NZS3000
5. All Plumbing and Electrical connections must be made in accordance with local regulations.
6. This HydroTap product is rated for 230V 50Hz AC operation.
7. Undersink units must never be located near, or cleaned with water jets.
8. Zip HydroTaps are not to be exposed to the elements of nature
9. Due to the process of continuous improvement, Zip Heaters reserves the right to change details mentioned in this manual, without notice.

## Major components and accessories

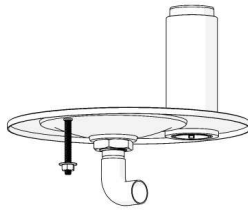
Parts supplied	Description
	HydroTaps with hoses. (Classic tap shown)
	1 off HydroTap Undersink Unit with water filter
	1 off Mains water connection hose
	1 x Inlet vent 1 x Outlet vent 9 x Screws
	1 x User guide 1 x Installation Instructions
	1 x Tee piece for Celsius ambient water supply

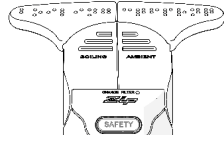
Accessories	Description
	Font Kit for Arc & Cube Models
	Font Kit for Classic & Elite Models
	Replacement Filter
	Disabled lever Kit (Classic Tap)

## Technical Specifications

### Residential models:

C = Chilled filtered

CHA = Chilled Hot and Ambient

D = Disabled lever controls, (Order as an option for Classic Tap )

**Note:** the standard Glass measurement =200ml

### Product covered by these instruction:

	Boost (10A)	GPO's Required	Power Rating (kW)	Unit Dimensions W x D x H (mm)	**Dry Weight (Kg)
Chilled Models					
C and CHA	no	1x10A	0.125	280 x 476 x 335	20

\*\* Add an extra 3 kg when full of water

### Before installing ensure that the following have been provided at the installation site:



- Review all the technical specifications.
- Ensure the underbench can support the product weight when full of water, (allow an extra 3 kg when full. )
- Sufficient space in the cupboard to install all of the undersink units in accordance with these Installation Instructions. Refer to technical specification for dimensions. Refer to section 3 & 4, for Installation instructions.
- The chilled HydroTap model requires a 220-240 Vac, 10A GPO



**NOTE: Check all cable and hose lengths against inlet /outlet positions before proceeding** (See section 3 for general layout).

- A potable water supply connection with isolating valve inside the cupboard within reach of the braided hoses and positioned so that the connection point and the stop cock will not be obstructed when the undersink units are installed.
- A cold water supply with a minimum working pressure of 172kPa and a maximum working pressure of 700kPa connected via an isolation valve.
- A separate Hot water supply for the Celsius mixer
- The appliance must be placed with it's base in a horizontal position.



**IMPORTANT!** Do not proceed with the Installation if these requirements are not met.

# Section 1 Tap Installation

Fit the tap to the benchtop or sink before installing the undersink unit.  
Refer to the tap installation book 803341



# Section 2

## Ventilation

When installing air flow ducts, the following tools will be required:

- Jigsaw and 12mm Drill
- Keyhole or Wall Board saw.

### 2.1 Ventilation for All Models

Proper air circulation must be provided for all Boiling and Chilled models. The system will operate correctly only if the recommended air gaps are achieved during Installation. The minimum requirement is for a 50mm air gap either side and 300mm above of the undersink unit.

It is important that the 4mm door buffers (For all installations ) are fitted to the inside edge of the cupboard door to allow sufficient air circulation inside the cupboard. (See the diagram below).



**IMPORTANT: See section 4 for clearances.**

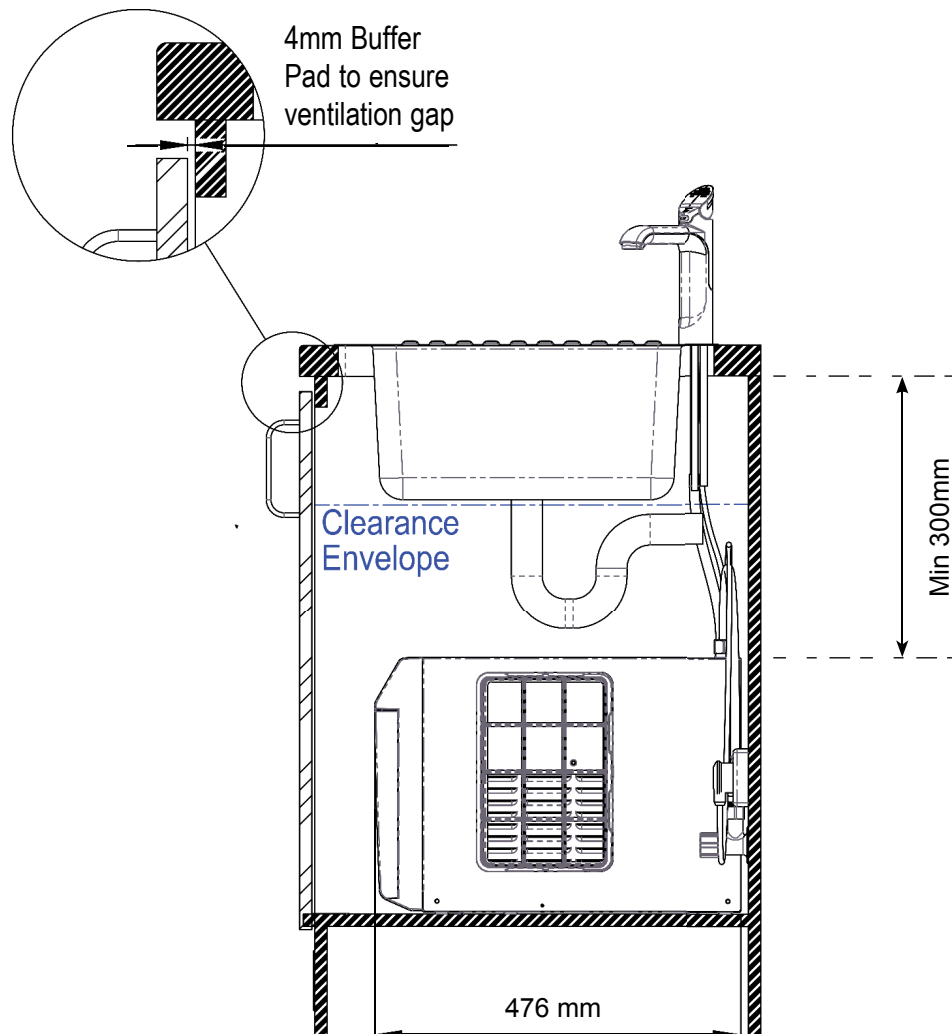

## Ventilation

### 2.2 The following instructions are critical if there is insufficient cupboard air circulation.

If the air flow, using the silicon door buffers, is insufficient, it will be necessary to fit a standard HydroTap vent kit, which ensures heat dissipation through natural convection via installed vents.

For high use applications, where the cupboard space temperature is near 35°C, or higher, the inlet vent (See Item B below) and silicon buffers, need to be fitted. If the airflow is still insufficient to maintain normal operating temperatures then the door outlet vent (See item D below) will need to be fitted.

Alternatively a fan kit may be installed, using the AUX din plug of the right hand side of the appliance (Contact your local service centre for availability).



**Note:** The vent kit has to be installed in a way that allows air to be drawn in from the bottom of the cupboard and expelled through the top of the cupboard. Therefore placement of the outlet vent should be towards the top of the door or on the side of the cupboard.

### Airflow through the cupboard

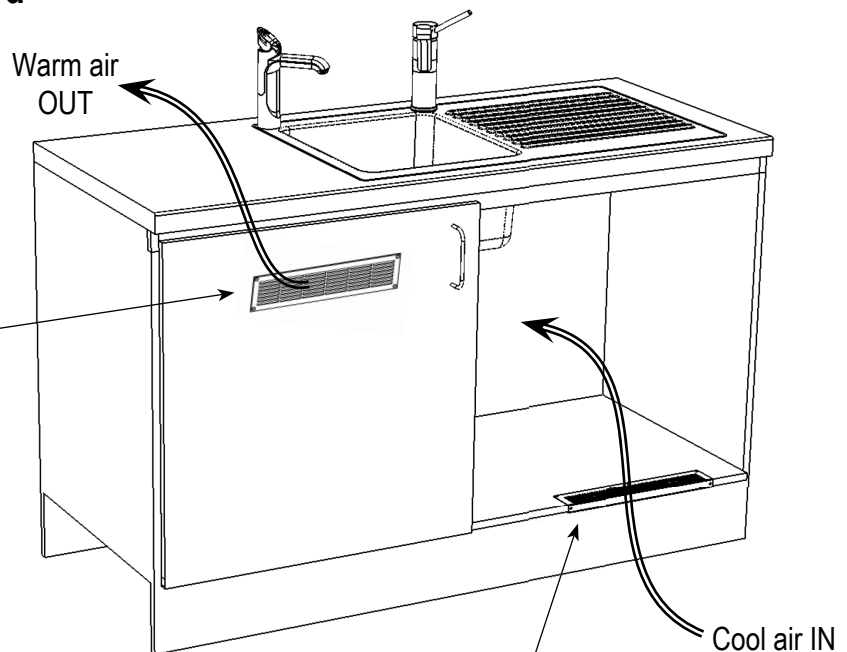
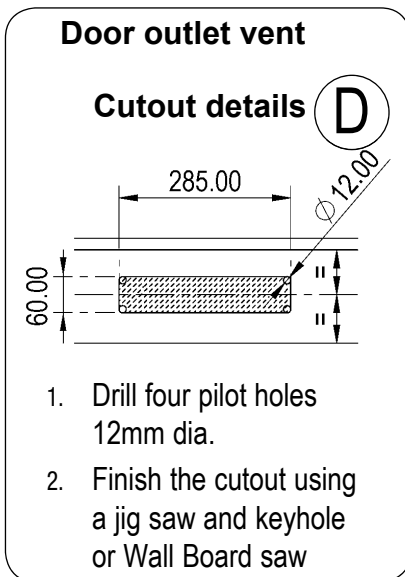

### Typical Cut out procedure

1. Mark out and cut the air inlet and door outlet holes as shown
2. Ensure the air inlet vent and air outlet vent are positioned at opposite ends of the same cupboard space.
3. Fit the inlet vent, as shown and secure with 5 screws
4. If required, fit the outlet vent, as shown in the hottest part (top) of the cupboard and secure with 4 screws

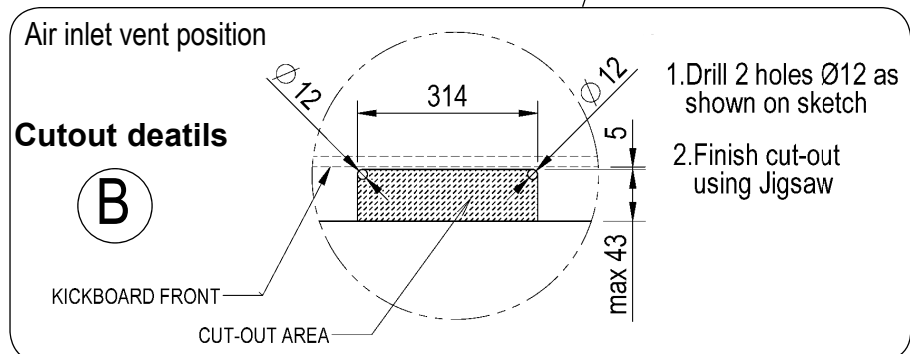

# Section 3

## Undersink Unit Installation

### 3.1 Hose and tube fitting. (Do not overtighten)

- Remove all caps from the top of the undersink unit ;
- Install the mains water braided hoses to the undersink unit before locating the unit in place.
- Fit the foam insulation to the Blue tube after trimming to length

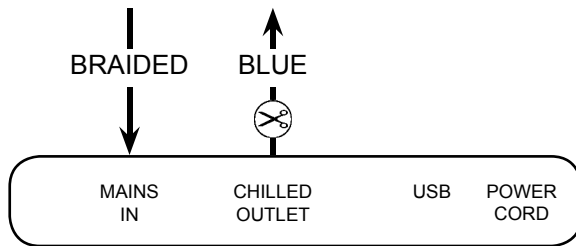

**Note:** All silicon tubes must be cut to size. They must have a constant fall back to the unit.

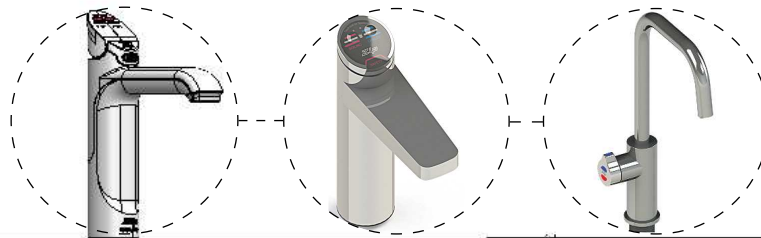

### 3.2 HydroTap C

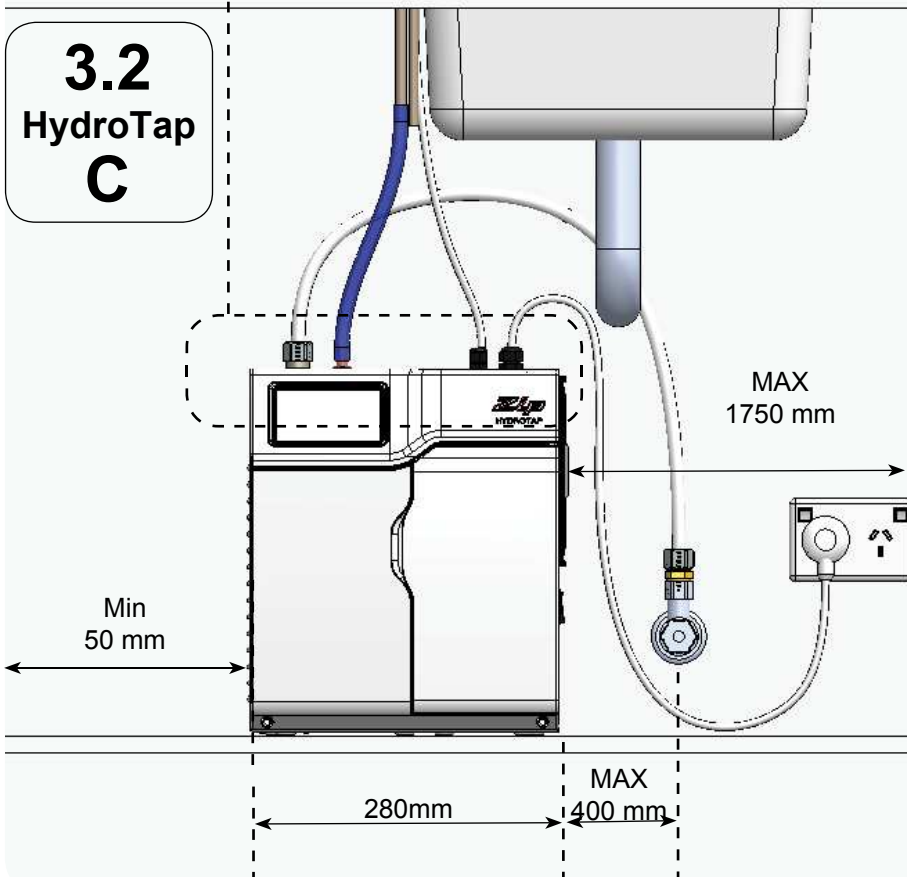

**Note:**  
 - Mains hose length is 750mm  
 - Plug and Cord length is 1800mm  
 Position the under sink unit close to the outlet tap, within reach of the hose and cord lengths supplied



**Note:** The tube lengths are matched to the pumps performance and therefore CANNOT be lengthened

## 3.3 - Celsius - CHA

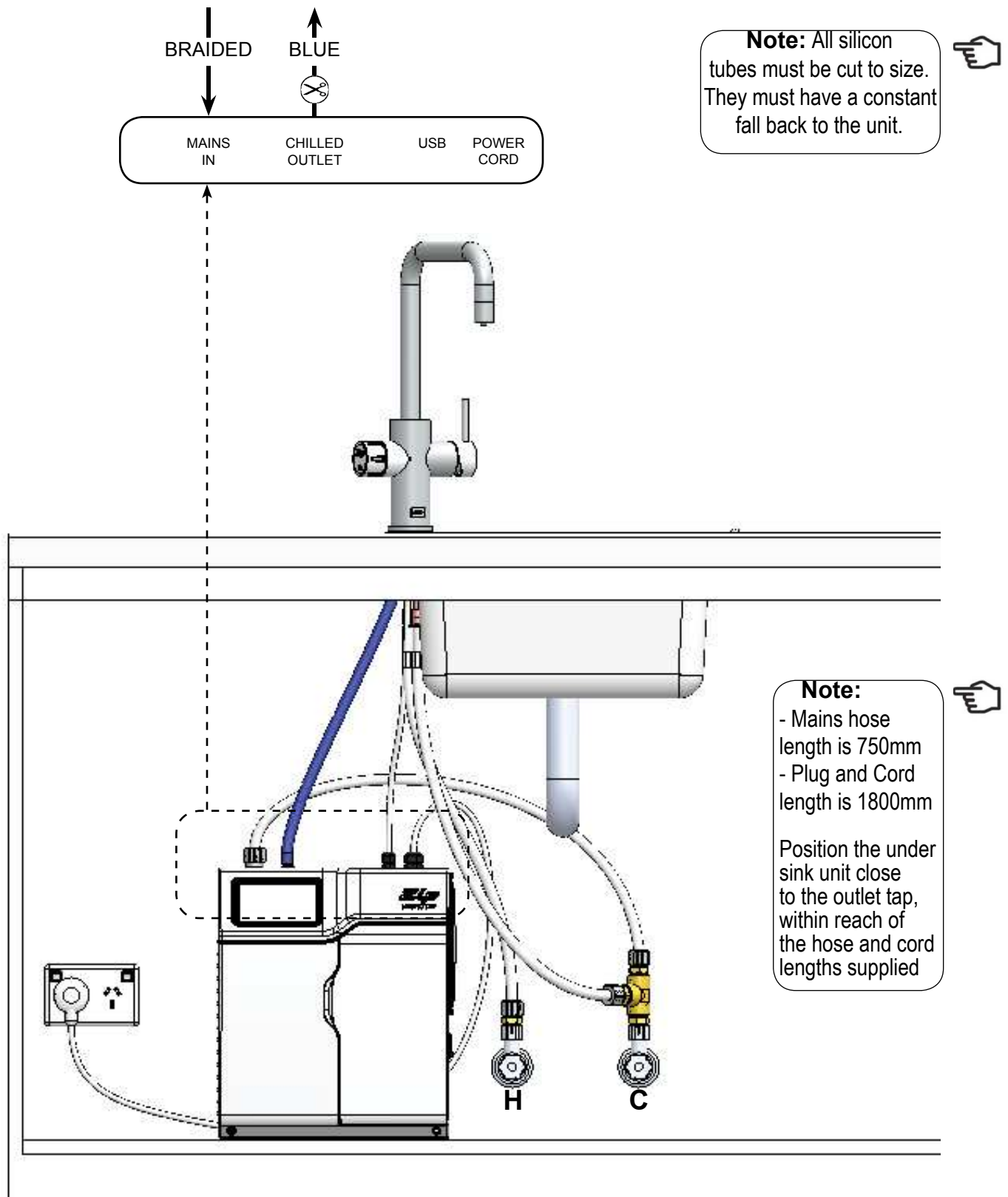

 Note: The tube lengths are matched to the pumps performance and therefore CANNOT be lengthened

# Section 4

## Commissioning

- Turn the power ON at the GPO and at the side of the undersink unit
- Turn ON the water and check for any leaks.
- At first commissioning, the screen will prompt you to select a language.
- Familiarise yourself with the operation of the Tap, in preparation for use (See User Guide)
- Follow the Installation instructions below (and review Section C of the User Guide).
- After commissioning, the system may be customised by selecting further options in Section G - Settings, within the User Guide.

### 4.1 - Select the Language

Initial Commissioning screen

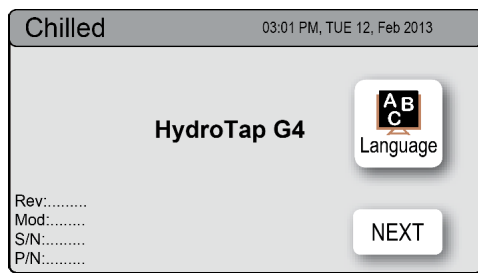

Language selection screen

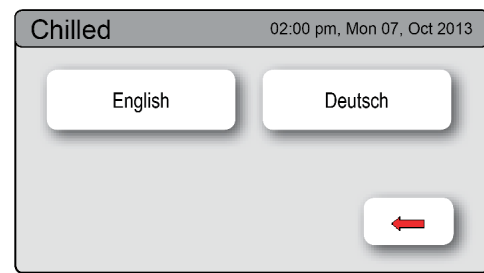

### 4.2 - Filter Flush

Have a 10L bucket or similar container (not supplied) at the ready to hold a quantity of water that will be ejected while the Filter Flush Mode is in operation. Open the filter access door on the front of the HydroTap and the filter cartridge will be exposed. Located to the rear RHS of the cartridge is a flush line, approx 600mm long and the flush line stop cock. Place the valve end of the flush line into the 10L bucket or container.

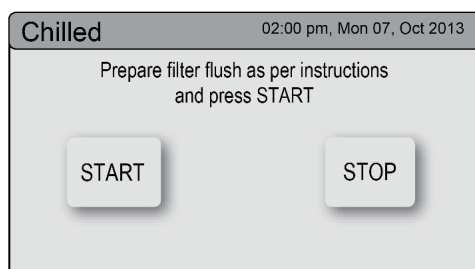
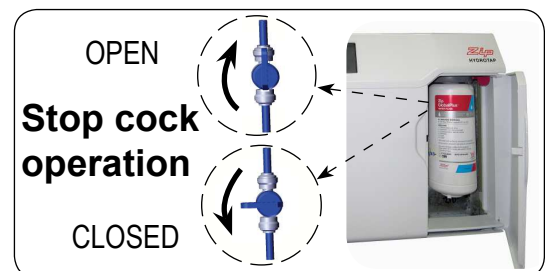

1. Turn the stop cock ON
2. Press [Start] [Stop] buttons to start and stop the filter flush.
3. Allow at least 10 litres of water to flush through the filter.
4. Once the filter flush is finished, Turn the stop cock OFF then press [Stop] to end filter flush mode.



**NOTE:** For any subsequent filter changes or any operational procedures, please refer to the HydroTap User Manual, located inside the filter housing access door.

## Trouble Shooting

System Fault Message	Possible Cause	Solutions
Power Board Fault	Electrical disruption	Check power supply and all fuses
Interface Fault	Internal fault	Call Zip Service
Level Board Fault	Internal fault	Call Zip Service
Condenser Screen Blocked	Blocked Air filter	Remove blockage / Clean filter / check user guide
Water leak, Isolate Mains	Water leak	Turn off mains water supply / Call for service
Compressor OverRun	Compressor too Hot	Check ventilation
Water Supply Failure	No water	Check water supply is turned ON
Cold Sensor Open	Internal fault	Call Zip Service
Cold Sensor Closed	Internal fault	Call Zip Service
Flood Sensor Open	Internal fault	Call Zip Service
Condenser Sensor Closed	Internal fault	Check Ventilation / Call Zip Service
Condenser Sensor Open	Internal fault	Check ventilation / Call Zip service
Compr. Driver Fault	No chilled water	Call Zip Service
Condenser Overtemp	Blocked airfilter	Remove blockage / Clean filter / check user guide
Calibration	Auto calibration reset	Normal operation, once per month
Overload Reset	Internal fault	Call Zip Service
Flash Mem corrupted	Internal fault	Call Zip Service
Flow Sensor Fault	Internal fault	Call Zip Service

Call an electrician, a plumber, or Zip for a free call in Australia on 1800-638-633 for assistance, service, spare parts or enquiries.



**NOTE:** For any subsequent filter changes or any operational procedures, please refer to the HydroTap user guide, located inside the filter housing access door.

## End of Life Disposal

In order to help preserve our environment we ask that you dispose of this product correctly. Please contact your local city council for collection centre details.

## Contact Details

### Head Office

Zip Heaters (Aust) Pty. Ltd.  
ABN: 46 000 578 727  
67 Allingham Street  
Condell Park NSW 2200  
Postal: Locked Bag 80  
Bankstown 1885 Australia

Website: [www.zipwater.com](http://www.zipwater.com)  
Facsimile: (02) 9796 3858  
Telephone: (02) 9796 3100  
Free Call: 1 800 638 633

As Zip policy is one of continuous product improvement, changes to specifications may be made without prior notice. Images in this booklet have been modified and may not be true representations of the finished goods.

The standard glass is 200 ml (7 fl oz).

The terms “Zip” and “HydroTap” are registered trade marks of Zip Heaters (Aust) Pty Ltd.

Zip products described in this publication are manufactured under one or more of the following patents: AU675601, AU637412, AU635979, GB0422305, GB2065848, US4354049, US5103859, US5099825 and SA2006/08043. Other patents are in force and patent applications are pending.

