

Zenith HydroTap® G4

Filtered Boiling, Chilled and Sparkling drinking water for Residential kitchens and tea rooms.

CS Residential

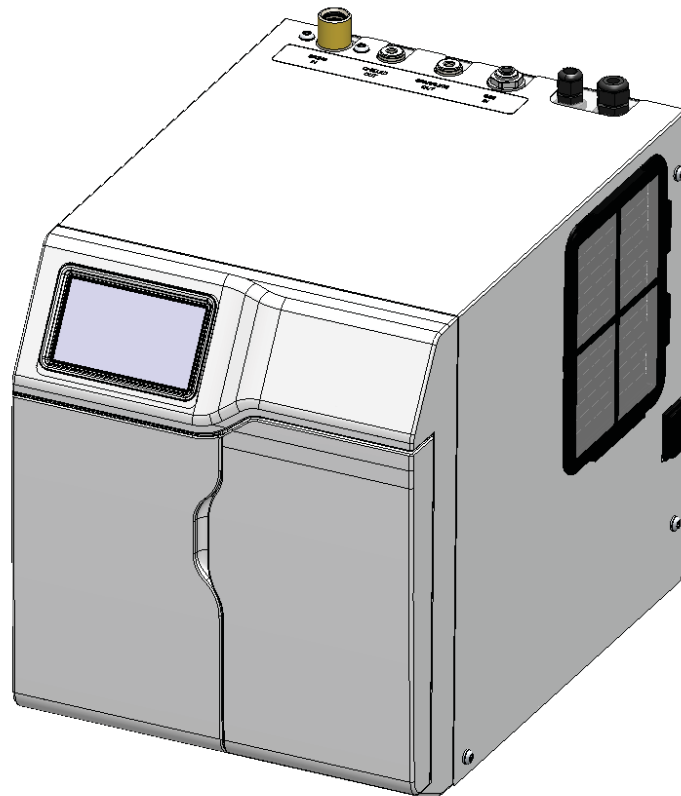

**Affix Model Number Label
Here
804052NZ**

Tap options

The HydroTap appliance series offers a range of interchangeable taps to suit the customer's needs (See options below). For ease of installation, it is recommended to fit the tap before installing the undersink unit. The installation procedure for each of the taps is detailed in a separate tap installation instruction book No. 803341NZ, supplied with the tap.

For all operational features of the HydroTap, please refer to the CS User manual No.801981NZ.



Classic Tap



Arc / Cube Tap



Elite Tap



Celsius Tap

HydroTap Specifications

Installation check list	4
General product features	5
Important Safety Instructions	6
Warnings and Regulatory Information.....	7
Major components and Accessories	8
Technical Specification	8
Before Installation and site requirements.....	9

STEP 1 - Measure and cut all the tap holes before fitting the taps

Section 1 - See Tap Installation instructions, (supplied with the tap) No. 803341

STEP 2 - Check for adequate ventilation

Section 2 - Ventilation

2.1 - Ventilation - All Models	10
2.2 - Ventilation diagram - CS Models	10-12

STEP 3 - Fit the CO₂ Gas cylinder

Section 3 - CO₂ Cylinder and Regulator

3.1 - Connect, secure and test the CO2 gas cylinder	13
3.2 - Connect the regulator	13
3.3 - Connect the gas hose to the regulator.....	13

STEP 4 - Install the underbench unit

Section 4 - Underbench unit installation

4.1- Hose and Tube fittings ; J.G. Fittings.....	14
4.2- Connect the gas hose to the undersink unit.....	14
4.3- Test for gas leaks.....	15
4.4- Installation and connection	15
4.5- Chilled Sparkling Models CS175	16
4.6- Celsius Chilled Sparkling Model CSHA175	16

STEP 5 - Commission the HydroTap

Section 5 - Commissioning

5.1- Select the language	17
5.2- CO Purge	17
5.3- Filter Flush	18

Trouble Shooting

Trouble Shooting Table.....	19
End of life disposal	19
Contact details	20

Installation checklist

Thank you for purchasing a Zenith HydroTap. Please read and follow these instructions carefully to ensure safe and trouble free service. If service is required, please call 1800 638 633

Before Installation:

- A. Read the instructions and check if there is adequate space to mount all of the components.
- B. **Note:** Not all fittings are supplied with the appliance kit. Isolation valves and special tools are not supplied (See Technical Specifications for details).
- C. Check the mains water pressure is between 250 - 700kPa
- D. Check the water quality to determine if extra filtration will be required.
Note: This product must be fitted to a potable water supply.
- E. Check the appliance rating plate and ensure correct power is available for the appliance.
- F. Check the under counter cupboard supporting the appliance is adequate for the total weight of the appliance, when full of water.

Before Commissioning:

- 1. Check the unit has been installed correctly.
- 2. Flush the supply line before connecting to the undersink unit.
- 3. Check all plumbing fittings have been tightened.
- 4. Ensure the outlet and vent pipes are positioned to drain correctly.
- 5. Ensure there is adequate ventilation.
- 6. Check all tubes from the underbench unit to the tap, have a constant rise and there are no sags or kinks in the hoses.
- 7. Check all electrical connections are correct and there are no loose wires.

Commission: (See section 5)

- 8. Turn on the gas and water and check for leaks.
- 9. Turn on the power.
- 10. Purge the CO₂
- 11. Flush the filter.
- 12. Where applicable, programme the unit to suit the customer's requirements.

General Product Features

What is the Zenith HydroTap ?

The Zenith HydroTaps are electronically controlled, filtered, Boiling, Chilled and Sparkling water, drinking systems for kitchens and tea rooms. The HydroTap units are under bench drinking water appliances with a dispensing tap mounted on a sink or bench, which may be used for residential applications. These units utilise a conventional refrigerant compressor to chill the water and (for BCS) an immersion heating element to boil the water and all utilise a CO₂ gas cylinder to carbonate the chilled water. Depending on the model, these units will dispense boiling water (factory set to 98°C) chilled water (factory set to 5-10°C) These units are NOT designed to be used for sanitary fixtures.

The boiling water units are fitted with a tap mounted, child safety lock. In addition, there are various energy saving options accessible via the main menu. Each boiling unit is equipped with a self-calibrating program which caters for altitude adjustment. The 2kg CO₂ bottle and the water filter are disposable items. Both will require periodic replacement and are covered by a limited OEM warranty.

It is important that the Installation be done safely, correctly and completely, in order to utilise all the benefits the HydroTap can provide. Each Classic and AIO HydroTap can be ordered with the Tap Head Assembly for Disabled use. The disabled levers are supplied with Braille caps for the visually impaired.

Usage:

The Zenith HydroTap is intended for use in residential household and similar applications such as, Rural and urban residential Kitchens, Hotels, Motels, Bed and Breakfast and other residential type environments

HydroTap CS and CSHA undersink unit

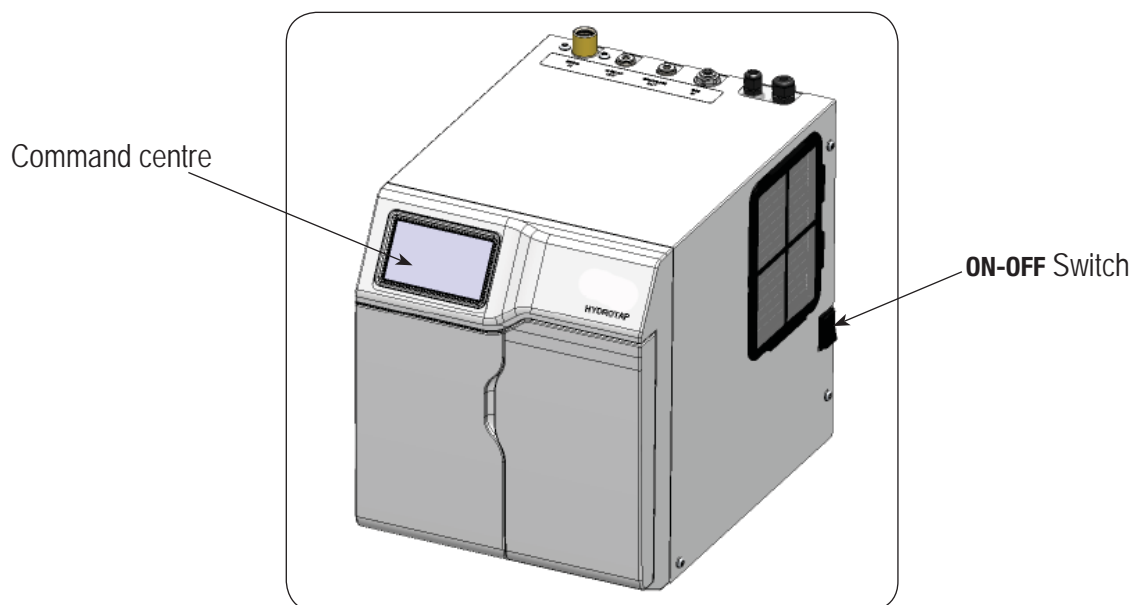

Important Safety Instructions

This manual contains important safety, Installation instructions for the Zenith HydroTap G4.

Safety

This appliance is not intended for use by persons (including children) with reduced physical, sensory or mental capabilities, or lack of experience and knowledge, unless they have been given supervision or instruction concerning use of the appliance by a person responsible for their safety. Children should be supervised to ensure that they do not play with the appliance.



For products sold in Europe, this appliance can be used by children aged from 8 years and above and persons with reduced physical, sensory or mental capabilities or lack of experience and knowledge if they have been given supervision or instruction concerning use of the appliance in a safe way and understand the hazards involved. Children shall not play with the appliance. Cleaning and user maintenance shall not be made by children without supervision.

Refrigerant

The Zenith HydroTap unit contains R134A refrigerant under pressure. Maintenance of the refrigeration unit must be carried out by an accredited service provider or qualified refrigeration technician.

Qualifications

If the power cable is damaged it must be repaired only by a qualified technician. To avoid hazards, all Installation procedures must be carried out by a suitably qualified tradesperson. The power cable and power outlet must be in a safe visible position for connection.

Venting

Ensure the tap body is located so the tap outlet safely dispenses into the sink bowl area.

Lifting

Take care when lifting the Zenith HydroTap unit. Some units may exceed safe lifting limits. If you feel this is beyond your personal capabilities, please seek assistance with the lift. The weights of the units are marked on the packaging. Do not lift the unit by the front cover or any connections at the top rear of the unit. Refer to the technical specifications for the weight of your product.

Airflow

The ambient operating temperatures, when installed in a cupboard, must be between 5°C - 35°C. The system will operate satisfactorily only if proper air ventilation is provided and only if the recommended air gaps of 50mm on each side are provided. See section 2 for correct ventilation details.

Positioning

It is important to ensure the underbench unit is positioned in an accessible area close to the floor level. The unit must have its base mounted in a horizontal position with all inlets and outlets facing up. The Tap must be located above the underbench unit. See section 4 for details.

Important Safety Instructions



WARNINGS





1. The Zenith HydroTap unit must be earthed. The resistance of the earth connection from each exposed metal part must be less than 1 ohm.
2. All Installation and service work must be completed by trained and suitably qualified Tradespeople. Faulty operation due to unqualified persons working on this product, or any other Zenith product may void warranty coverage.
3. All Plumbing must comply with AS/NZS3500.
4. All Electrical must comply with AS/NZS3000
5. All Plumbing and Electrical connections must be made in accordance with local regulations.
6. This HydroTap product is rated for 230V 50Hz AC operation.
7. Underbench units must never be located near, or cleaned with water jets.
8. Zenith HydroTaps are not to be exposed to the elements of nature
9. Due to the process of continuous improvement, Zenith Heaters reserves the right to change details mentioned in this manual, without notice.



CO₂ Cylinder Warnings:

- Pressurised container.
- Protect from sunlight.
- Contains gas under pressure, may explode if heated.
- Do not expose to temperatures exceeding 50°C.
- Do not pierce or burn, even after use.
- Do not refill – non rechargeable
- Ensure cylinder is empty before disposal.
- Do not expose to naked flame or any incandescent material.
- Keep out of reach of children.
- High concentration of gas may cause asphyxiation.
- Use only in ventilated areas.
- Unless well ventilated, store the cylinder in an area no less than 20 cubic meters for each kg of gas. (See section 4)
- Use only in an upright position.
- This bottle must be used with the approved pressure regulator.
- Avoid shock.
- Use according to MSDS. (Material Safety Data Sheet).

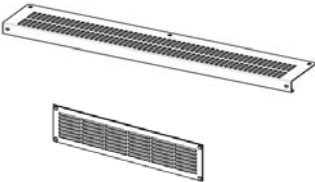

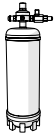
Major components and accessories

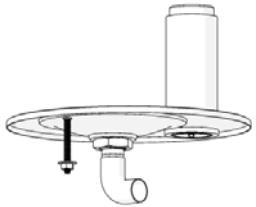
Parts supplied	Description
	1 off 4 HydroTaps with hoses (Classic tap shown)
	1 off HydroTap Undersink Unit with air and water filters
	1 off Mains water connection hose
	Vent Kit 1 x Inlet vent 1 x Outlet vent 9 x Screws
	1 x User guide and 1 x Quick start guide
	1 off CO ₂ gas cylinder & regulator assy.

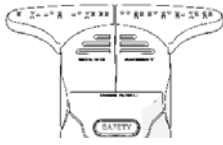
Accessories	Description
	Font Kit for Arc & Cube Models
	Font Kit for Classic & Elite Models
	Replacement Filter
	Disabled lever Kit

Technical Specifications

Product covered by these instructions:

- CS = Chilled Sparkling, Filtered
- CSHA = Chilled Sparkling, Hot & Ambient (Mains)
- D = Disabled lever controls, (Order as an option)

NOTE: chilled water will continue to be dispensed after the rated capacity has been used, although this may be at slightly higher temperature.

	GPO's Required	Power Rating (W)	Booster Rating (W)	Unit Dimensions W x D x H (mm)	**Dry Weight (Kg)
Chilled Sparkling					
CS	1x10A	1700	N/A	280 x 405 x 333	30
Celsius					
CSHA	1x10A	1700	N/A	280 x 405 x 333	30

** Add an extra 5 kg when full of water

Before Installation



Before installing ensure that the following have been provided at the Installation site:

- Review all the technical specifications.
- Ensure the underbench can support the product weight when full of water, (allow an extra 5kg when full.)
- Sufficient space in the cupboard to install all of the undersink units in accordance with these Installation Instructions. Refer to technical specification for dimensions. Make allowance for a booster heater and / or water softener if required. Refer to section 3 & 4, for Installation instructions.
- For Zenith HydroTap CS and CSHA models, a 220-240Vac, 10A GPO will be required.



Note: Check all cable and hose lengths against inlet /outlet positions before proceeding (See section 5 for general layout).



- A potable water supply connection with isolating valve inside the cupboard within reach of the braided hoses and positioned so that the connection point and the stop cock will not be obstructed when the undersink units are installed.
- For the mains pressure CSHA, an external hot and cold water supply will be required.
- A cold water supply with a minimum working pressure of 250kPa and a maximum working pressure of 700kPa connected via an isolation valve.
- The appliance must be placed with it's base in a horizontal position.

IMPORTANT! Do not proceed with the Installation if these requirements are not met.

Special Tools Required:

In addition to normal tools, the following will be required:

For the standard and Mixer taps:

- 35mm diameter sheet metal hole punch for sink tops. (Not supplied)
- 35mm diameter hole saw for timber bench tops. (Not supplied)
- Nut runner tube spanner (supplied) for fixing tap assembly.

Section 1 Tap Installation

Fit the Tap to the benchtop or sink before installing the undersink unit.
Refer to the tap installation book 803341NZ

Section 2

Ventilation

When installing air flow ducts, the following tools will be required:

- Jigsaw and 12mm Drill
- Keyhole or Wall Board saw.

2.1 Ventilation for All Models

Proper air circulation must be provided for all Boiling and Chilled models. The system will operate correctly only if the recommended air gaps are achieved during Installation. The minimum requirement is for a 50mm air gap either side and 300mm above of the undersink unit.

It is important that the 4mm door buffers (For all installations) are fitted to the inside edge of the cupboard door to allow sufficient air circulation inside the cupboard. (See the diagram below).



IMPORTANT: See section 4 for clearances.

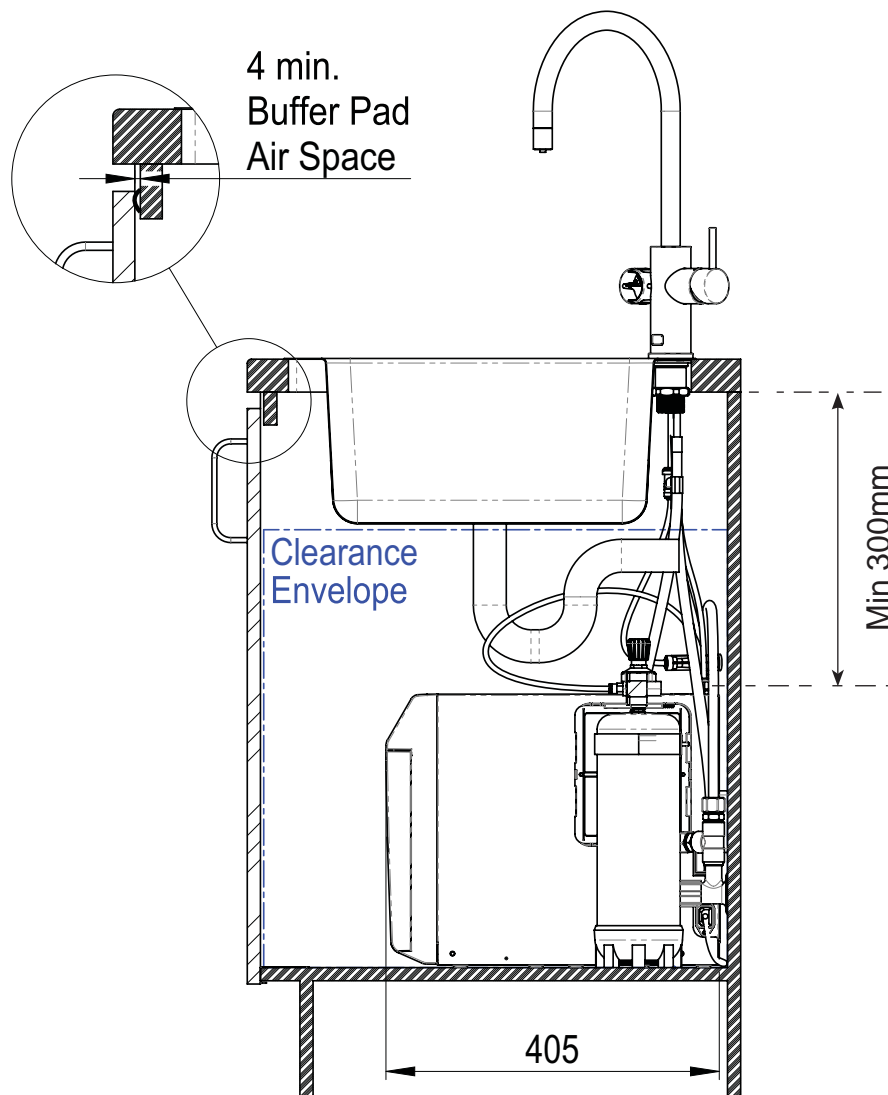

Ventilation

2.2 The following instructions are critical if there is insufficient cupboard air circulation.

If the air flow, using the silicon door buffers, is insufficient, it will be necessary to fit a standard HydroTap vent kit, which ensures heat dissipation through natural convection via installed vents.

For high use applications, where the cupboard space temperature is near 35°C, or higher, the inlet vent (See Item B below) and silicon buffers, need to be fitted. If the airflow is still insufficient to maintain normal operating temperatures then the inlet vent and door outlet vent (See item D below) will need to be fitted.

 **Note:** The vent kit has to be installed in a way that allows air to be drawn in from the bottom of the cupboard and expelled through the top of the cupboard. Therefore placement of the outlet vent should be towards the top of the door or on the side of the cupboard.

Airflow through the cupboard

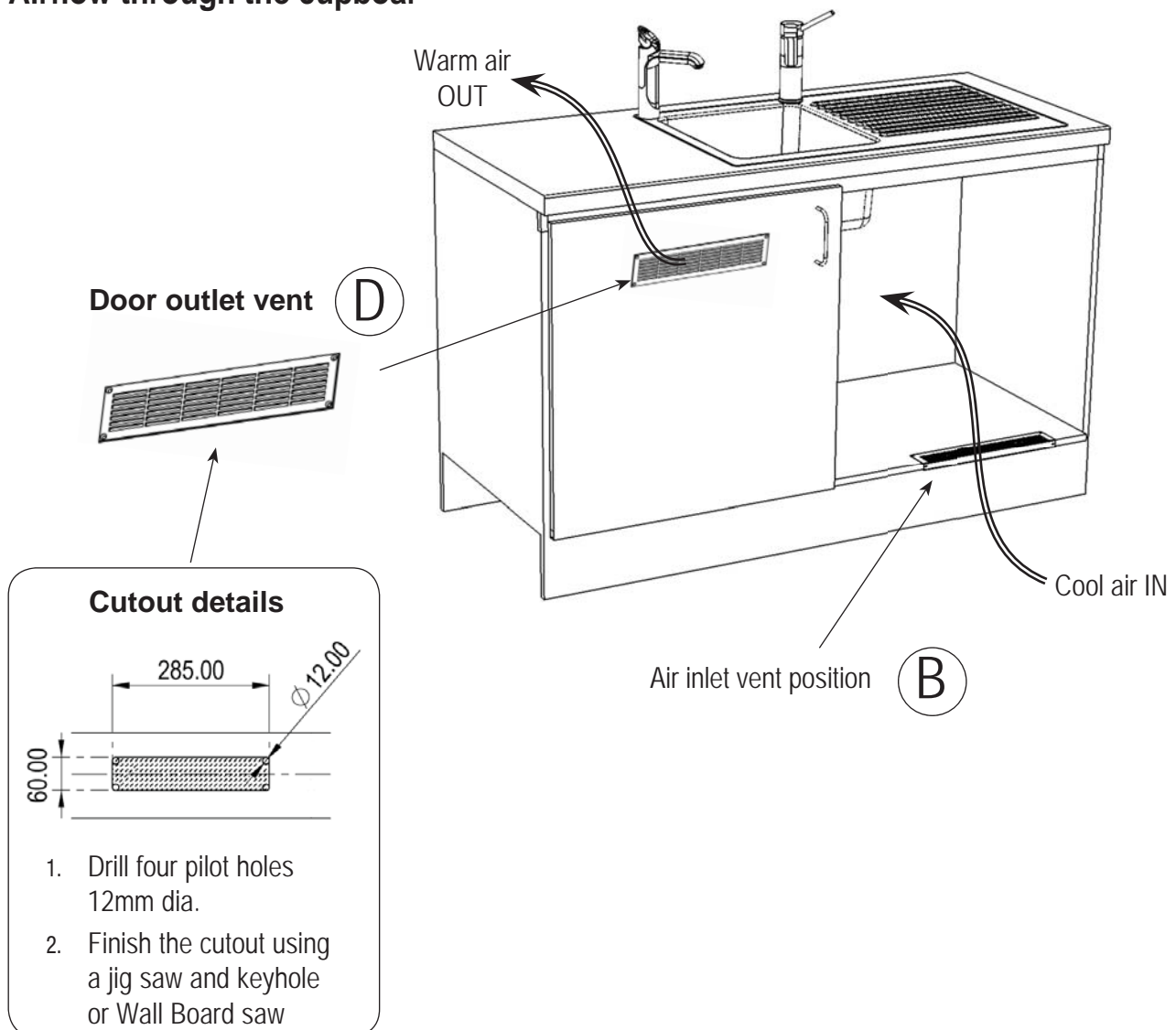

Ventilation

Typical Cut out procedure for



1. Mark out and cut the air inlet and door outlet holes as shown
2. Ensure the air inlet vent and air outlet vent are positioned at opposite ends of the same cupboard space.
3. Fit the inlet vent, as shown and secure with 5 screws
4. If required, fit the outlet vent, as shown in the hottest part (top) of the cupboard and secure with 4 screws

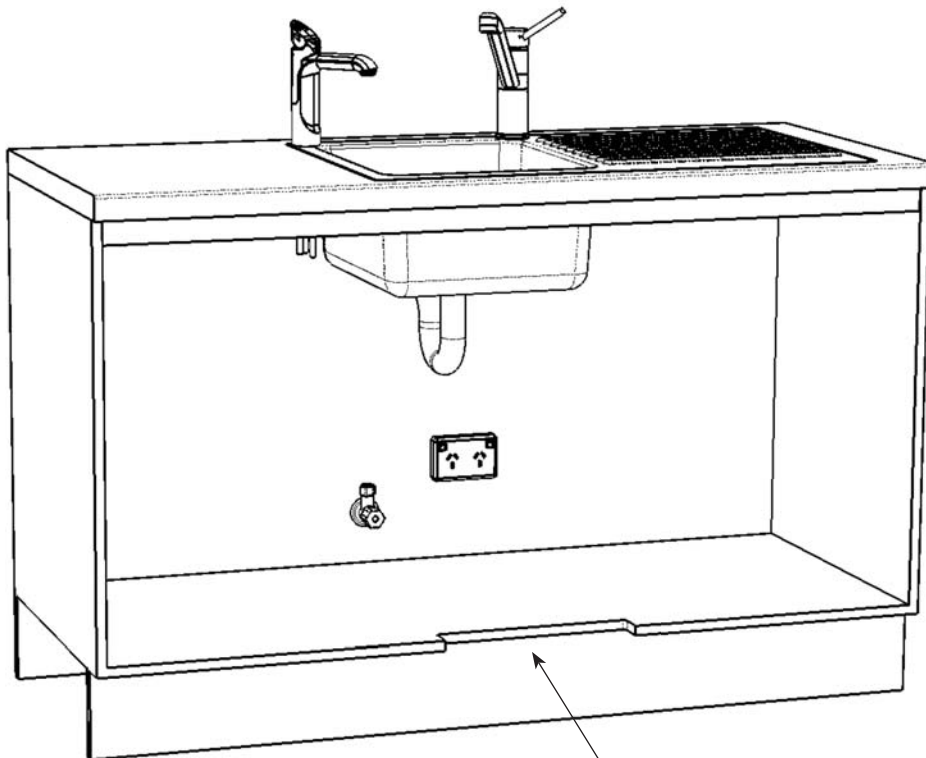

Air inlet vent

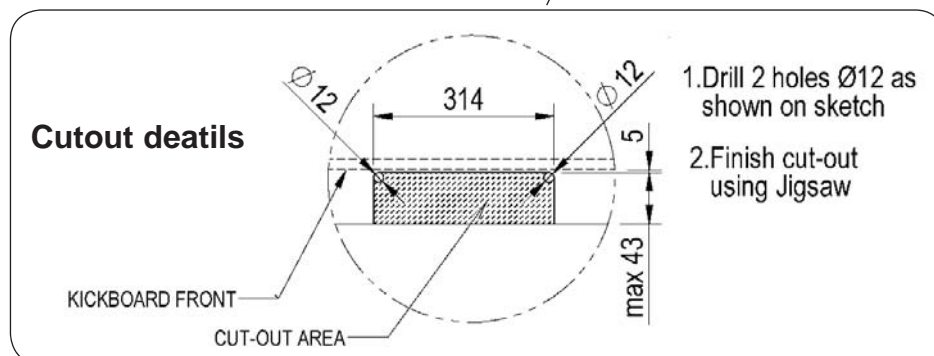
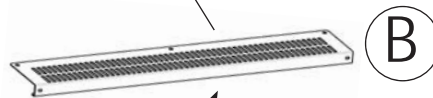

Section 3

CO₂ Cylinder



WARNING:

This cylinder must be installed in an open plan area or in an enclosed room, with a volume no less than 20m³. If more than 1 gas cylinder containing CO₂ is present within the same location, the recommended ventilated area should be in proportion to the number of gas cylinders stored in that location.

A ventilated area is a non-enclosed area which could include the kitchen, living room etc.

See gas bottle and MSDS sheet for a complete list of warnings. (See: www.Zenithindustries.com)

Turn the knob fully clockwise before fitting the regulator

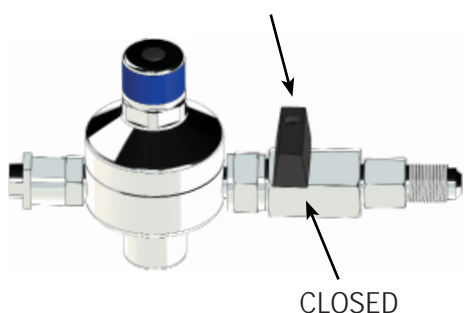

3.1 Secure the cylinder mounting:

Secure the gas bottle supplied to a suitable wall, within 1 metre of the unit, in an upright position. This is done by screwing the metal plate holding the hook-and-loop strap to a cupboard wall, 200mm above the floor or base of the cupboard. Make sure the gas bottle can stand before securing to the wall.

Due to regulatory requirements the gas bottle must be stored securely and in an upright position.

3.2 Connect the regulator:

Rotate the knob fully anti-clockwise to turn the gas on.

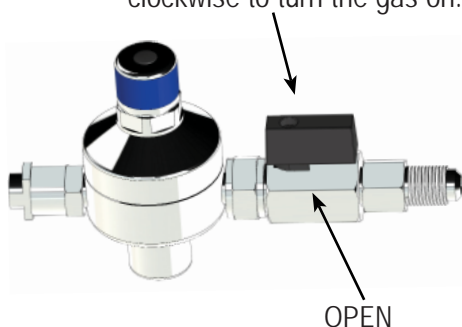

Make sure the regulator knob is turned fully clockwise to the end-stop before fitting see fig.1. Fit the regulator to the gas bottle. Be aware that some CO₂ may be discharged from the connection to the regulator as the bottle and the regulator are assembled together. Any CO₂ released will be cold. Continue to screw on the regulator to stop this leakage.

Note: The regulator comes pre-set fixed pressure at 300kPa.

3.3 Connect the gas hose:

Connect the braided gas hose to the top of the undersink unit via the John Guest fitting marked 'CO₂ IN'. Then connect the threaded end to the regulator, taking care not to lose the plastic olive located inside the threaded nut. To turn the gas ON, rotate the regulator knob anti-clockwise to the end-stop.

Section 4

Undersink Unit Installation

John Guest fittings (Insertion and removal)

Be careful when cutting the poly tube so that there are no rough edges and that the tube is not distorted.

1. Use a sharp knife to ensure the tube has a clean, straight edge. Do not cut at an angle.
2. Remove any swarf or unwanted material.
3. Push the tube into the John Guest fitting making sure all connections to the John Guest fittings are pushed in past the "O"ring to full depth, at least 15-16mm.
4. Check for a good joint by pulling back on the tube. If the tube comes out, of the fitting, repeat the above step.
5. To remove the tube, press the collet into the fitting and at the same time pull back on the tube.

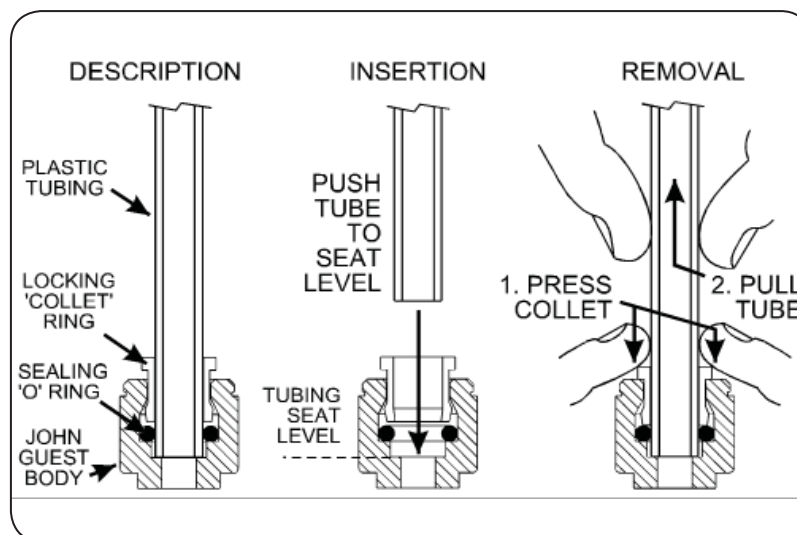

Installation

4.1 Hose and tube fitting. (Do not overtighten)

- Remove all caps from the top of the undersink unit
- Fit the foam insulation to the Blue and to the White tubes after trimming them to length
- Install the mains water braided hoses to the undersink unit before locating the unit in place.



Test for leaks at these two points



4.2 Test for gas leaks:

Using soapy water perform a leak test. Turn the gas OFF. Apply the soapy water to the gas connections using a sponge or brush. Cover all of the gas joints with a liberal amount of suds.

Turn ON the gas. Inspect the joint for leaks. If any bubbles appear and grow, there is a gas leak at the connection. The joint will need to be resealed and tested again. Clean away the soapy residue and tighten or refit the leaking connection. Make sure the regulator is turned off when tightening or refitting the leaking connection.

Refit the gas bottle to the hook-and-loop strap and secure the bottle in an upright position.

NOTE: Care must be taken when working with high pressure carbon dioxide.

IMPORTANT:

After replacing a bottle or after making a gas connection, check for gas leaks between regulator and bottle, and between regulator and braided hose.

Installation Instructions

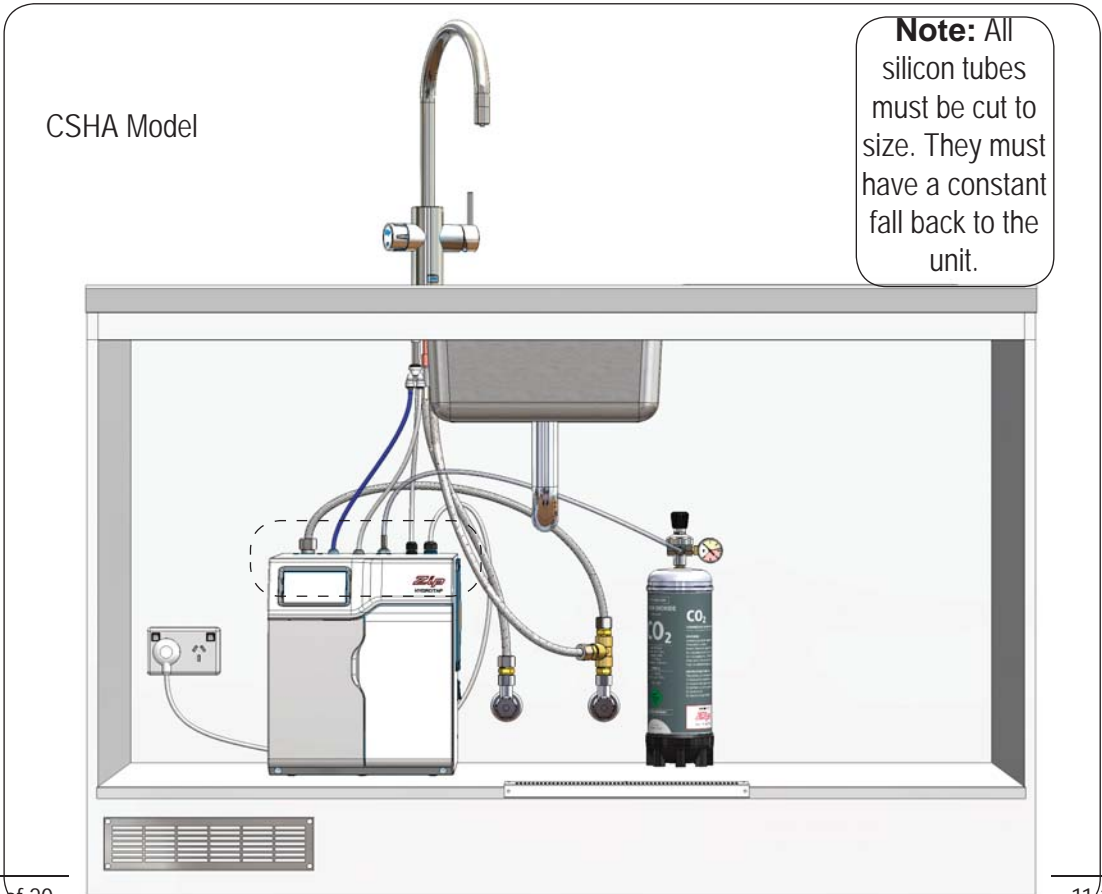
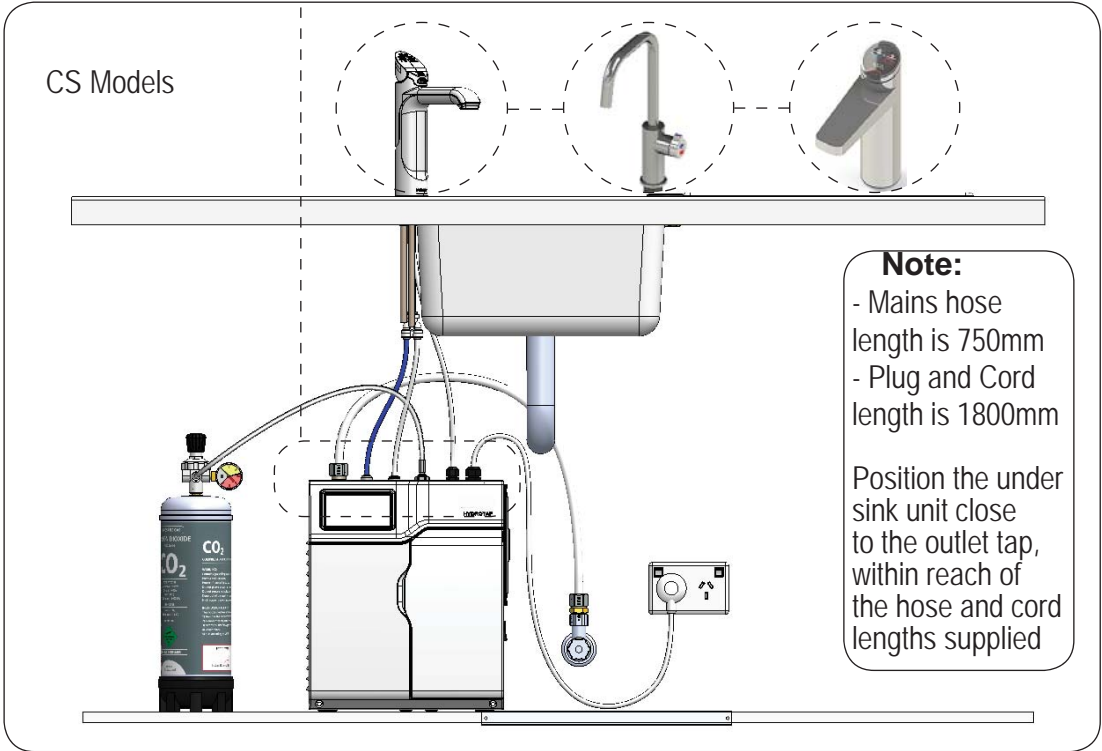
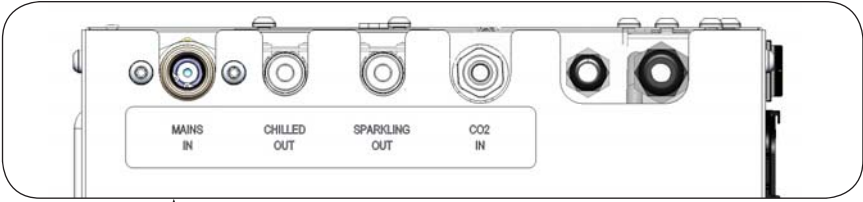

Section 5

Commissioning

The HydroTap is now ready to be commissioned.

- Turn ON the water and gas and check for any leaks.
- Turn the power ON at the GPO and at the side of the undersink unit
- Familiarise yourself with the operation of the Tap, in preparation for use (See User Manual)
- Follow the Installation instructions below (and review Section C of the User Manual).
- Initially you will be prompted to select a language
- After commissioning, the system may be customised by selecting further options in Section G - Settings, within the User Manual.

5.1 - Select the Language

Initial Commissioning screen

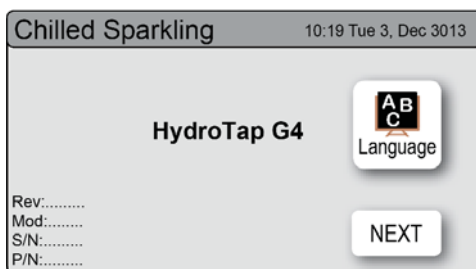

Language selection screen

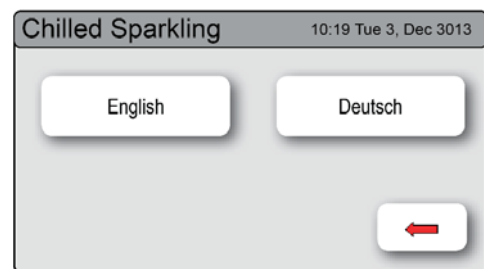

5.2 - CO₂ Purge



1. Press the [START] button to commence the purging process.
2. Purge for 10 seconds and ensure all water has stopped flowing through the tap. (You will hear the CO₂ gas escaping from the tap).
3. Press the [Stop] button.
4. Press [Next] for the filter flush screen

5.3 - Filter Flush

Have a 10L bucket or similar container (not supplied) at the ready to hold a quantity of water that will be ejected while the Filter Flush Mode is in operation. Open the filter access door on the front of the HydroTap and the filter cartridge will be exposed. Located to the rear RHS of the cartridge is a flush line, approx 600mm long and the flush line stop cock. Place the valve end of the flush line into the 10L bucket or container.

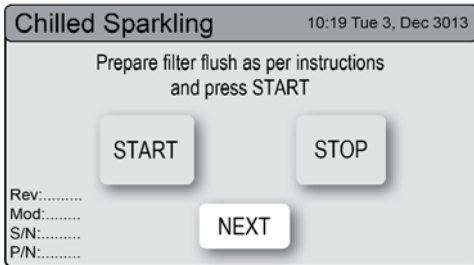
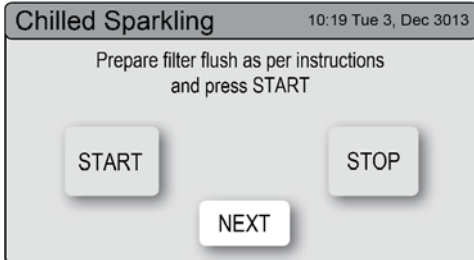

1. Press [Start] [Stop] buttons to start and stop the filter flush.
2. Turn the flush line stop cock ON (See diagram).
3. Press [Start] and allow at least 10 litres of water to flush through the filter.
4. The product details will be displayed in the screen.
5. Once the filter flush is finished, Turn the stop cock OFF then press [Stop] to end filter flush mode.
6. Press [Next] for the Boiling Calibration screen.

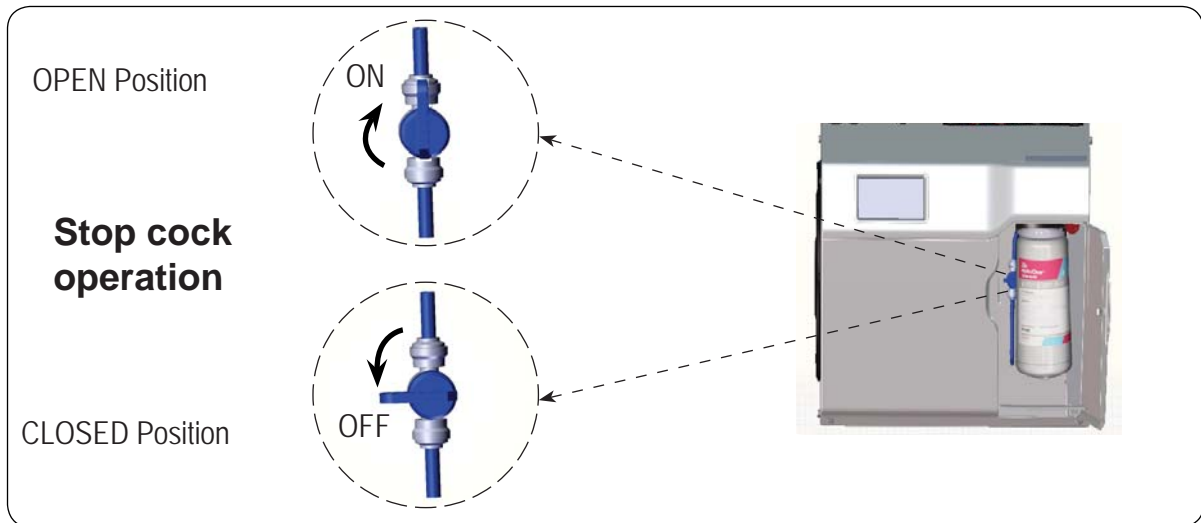

NOTE: For any subsequent filter changes or any operational procedures, please refer to the HydroTap user guide, located inside the filter housing access door.

Trouble Shooting

System Fault Message	Possible Cause	Solutions
Power board fault	Electrical disruption	Check power supply and all fuses
Interface fault	Internal fault	Call Zenith Service
Level board fault	Internal fault	Call Zenith Service
Condenser screen blocked	Blocked Air filter	Remove blockage / Clean filter / check user guide
Water leak, Isolate mains	Water leak	Turn off mains water supply / Call for service
Compressor over-run	Compressor too Hot	Check ventilation
Water supply failed	No water	Check water supply is turned ON
Cold sensor Open	Internal fault	Call Zenith Service
Cold sensor Closed	Internal fault	Call Zenith Service
Flood sensor Open	Internal fault	Call Zenith Service
Condenser sensor Closed	Internal fault	Check Ventilation / Call Zenith Service
Condenser sensor Open	Internal fault	Check ventilation / Call Zenith service
Compressor driver fault	No chilled water	Call Zenith Service
Condenser overtemp.	Blocked air filter	Remove blockage / Clean filter / check user guide
A DC Pump is faulty	Internal fault	Call Zenith Service
Comp Fuse/Driver Fault	Internal fault	Call Zenith Service
Flash Mem corrupted	Internal fault	Call Zenith Service
Flow Sensor Fault	Internal fault	Call Zenith Service

Call an electrician, a plumber, or Zenith for a free call in Australia on 0800 558055 for assistance, service, spare parts or enquiries.

End of Life Disposal

In order to help preserve our environment we ask that you dispose of this product correctly. Please contact your local city council for collection centre details.

Contact Details

Head Office

Zenith Heaters Limited,
IRD No. 95 640 729
Unit 2/15 Moselle Avenue,
Henderson.
Auckland. 0610
New Zealand.

Website: www.zenithheaters.co.nz

Int. Phone: +(64 9) 838 8612
Telephone: 0800 558055
Facsimile: 0800 559055

As Zenith policy is one of continuous product improvement, changes to specifications may be made without prior notice. Images in this booklet have been modified and may not be true representations of the finished goods.

The terms "Zenith" and "HydroTap" are registered trade marks of Zip Heaters (Aust) Pty Ltd.

Zenith products described in this publication are manufactured under one or more of the following patents: AU675601, AU637412, AU635979, GB0422305, GB2065848, US4354049, US5103859, US5099825 and SA2006/08043. Other patents are in force and patent applications are pending.



zenith°